



March 30, 2006

Ms. Sharon Fisher
Harley-Davidson Motor Company Operations, Inc.
1425 Eden Road
York, PA 17402

Re: 2005 Summary of Operation for
North Building 4 Soil Vapor Extraction System
Harley-Davidson Motor Company Operations, Inc.
SAIC Project 01-1633-00-8342-800

Dear Sharon:

Science Applications International Corporation (SAIC) is providing this letter to summarize operation of the North Building 4 (NB4) soil vapor extraction (SVE) system during 2005. The NB4 SVE system is located at the York, Pennsylvania facility of Harley-Davidson Motor Company Operations, Inc. (Harley-Davidson). Through calendar year 2005, the system has been in operation for approximately 11 years (startup occurred in May 1994).

The purpose of the SVE system is to extract soil vapor containing volatile organic compounds (VOCs) from up to five multi-level, vapor extraction wells (VEWs) located beneath the floor at the north end of Building 4. Each of the VEWs is connected via schedule 40 polyvinyl chloride (PVC) piping to a blower unit housed in a wooden shed located on the west side of Building 4 (refer to Figure 1). The blower unit applies a vacuum to the VEWs and transmits the extracted soil vapor via a 6-inch diameter schedule 80 PVC underground pipe to Building 41 for treatment. The soil vapor is passed through either a Thermal Fume Oxidizer (TFO) unit or a granular activated carbon (GAC) unit for destruction/absorption of the VOCs.

During 2005, the SVE system operated for a total of 8,031 hours (or 334.6 days) of a possible 8,760 hours (365 days). These data indicate that the SVE system was functional for approximately 92 percent of the available time. The SVE system was only off for consecutive days on five occasions. None of these periods of downtime was attributable to maintenance problems associated with the SVE system. A summary of the periods of downtime is presented below:

- The SVE system was off for approximately eight days in late January due to saturation of the granular activated carbon (GAC) unit. Once the GAC unit was replenished, the groundwater treatment system (GWTS) and the SVE system were re-started.
- The SVE system was off for approximately two days in late June during piping upgrades between the equalization tank and the packed tower aerator. These changes resulted in complete shut down of the entire GWTS, including the SVE system.
- The SVE system was down for approximately two days during the first week in August. The entire GWTS was off during this same period due to on-site construction activities unrelated to the GWTS.

- The SVE system was off for approximately three days in mid October as a result of reliability upgrades that were completed on the GWTS.
- From October 31 to November 3, the SVE system did not operate. The entire GWTS was down during this time period in order to install a new duct heater for the GAC unit.

During 2005, SAIC performed monthly monitoring of the SVE system that included recording air flow data (refer to Table 1) and photoionization detector (PID) readings at up to seven vapor extraction points (refer to Figure 2). The seven locations that are sampled include EW-1 gravel, EW-1D, EW-2D, EW-3S, EW-4D, the gravel pit, and the total system influent (combined, prior to the blower). The remaining extraction points were shut off in early 2000 due to their very low VOC recoveries, and to enhance VOC recovery at the remaining locations.

SAIC typically collects soil vapor samples from active vacuum extraction wells on a quarterly basis. Four sampling events (February, April, July and October) were performed in 2005. The air samples were analyzed by VaporTech Services, Inc. of Valencia, Pennsylvania for five VOCs including:

- 1,1,1-Trichloroethane (TCA)
- Trichloroethene (TCE)
- Tetrachloroethene (PCE)
- cis-1,2-Dichloroethene (cis-1,2-DCE)
- Vinyl chloride

Table 2 summarizes the laboratory analytical results while Figures 3 through 6 graphically display the historical VOC data by sampling location. The total influent VOC concentrations measured during 2005 were generally consistent with data collected in 2004, but lower than pre-2004 concentrations. The historical range in VOC abundance (in the influent), followed by the 2005 percent by volume in the influent, is summarized for each parameter below:

- TCA: historically has ranged from 52 to 76 percent; averaging 53 percent in 2005.
- TCE: has ranged from 17 to 30 percent; averaging 29 percent in 2005.
- PCE: has ranged from 5 to 21 percent; averaging 16 percent in 2005.
- cis-1,2-DCE: has ranged from 0.1 to 2 percent; averaging 2 percent in 2005.
- Vinyl chloride: This parameter was added to the analytical suite in 2003 due to its recent occurrence in groundwater at collection well CW-15A (close to the NB4 SVE system). Vinyl chloride has not been detected in air samples since 2003.

Based upon a review of gas chromatography (GC) analysis and air flow data, SAIC estimates that approximately 61 pounds of VOCs were removed by the SVE system during 2005. This value is greater than the quantity removed during calendar year 2004 (approximately 55 pounds). This apparent increase in VOC removal is explained by the fact the SVE system logged more run time in 2005 compared to 2004 (8,031 versus 6,986 hours). A cumulative VOC recovery of approximately 35,008 pounds has been recorded since system start-up (refer to Figure 7 and Table 1).

If you have any questions or comments regarding this letter, please do not hesitate to contact either of the undersigned.

Very truly yours,

SCIENCE APPLICATIONS INTERNATIONAL CORPORATION

Scott L. McFeaters, P.G.
Project Scientist

Rodney G. Myers
Project Manager

cc: Ralph T. Golia – AMO Environmental Decisions
Stephen Snyder – SAIC

FIGURES

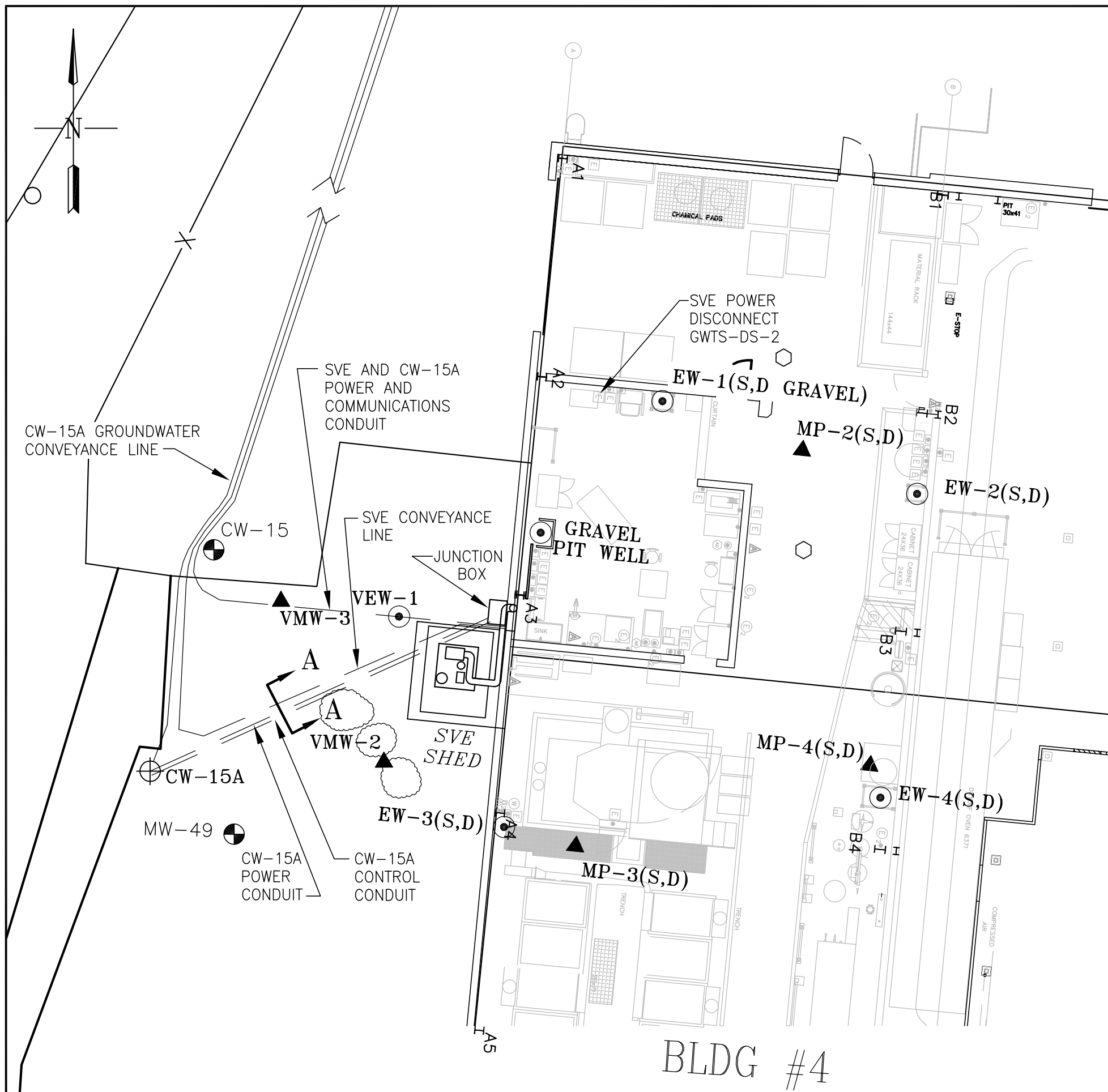

LEGEND

- EW-2(S,D) SOIL VAPOR EXTRACTION WELL LOCATION AND DESIGNATION
- ▲ MP-2(S,D) SOIL VAPOR EXTRACTION MONITORING POINT LOCATION AND DESIGNATION
- ⊙ CW-15 GROUNDWATER MONITORING WELL LOCATION AND DESIGNATION
- ⊕ CW-15A GROUNDWATER COLLECTION WELL LOCATION AND DESIGNATION
- ⬡ LOCATION OF TEMPORARY "CAUTION MEN WORKING" SIGN

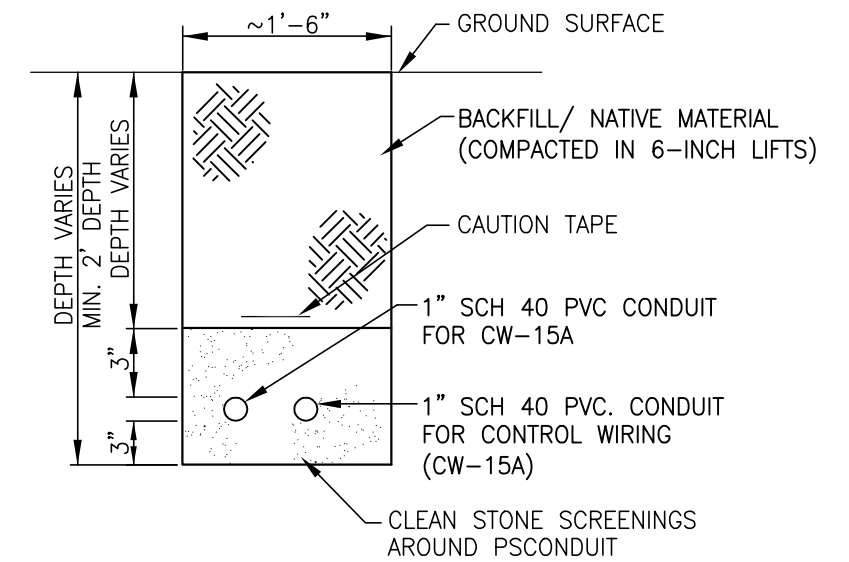

TRENCH SECTION A-A



HARLEY-DAVIDSON MOTOR COMPANY OPERATIONS, INC. YORK VEHICLE OPERATIONS 1425 EDEN ROAD, YORK, PA 17402			
SOIL GAS EXTRACTION SYSTEM NORTH BUILDING 4 AREA			
drawn RAM	checked SLM	approved RGM	figure no.
date 12/02/05	date 11/24/04	date 11/24/04	1
job no. 01-1633-00-5389-067		file no. 0M2004-016.dwg	

FIGURE 2
2005 North Building 4 SVE PID Measurements
 Harley-Davidson Motor Company Operations, Inc.
 York Vehicle Operations
 1425 Eden Road, York PA 17402

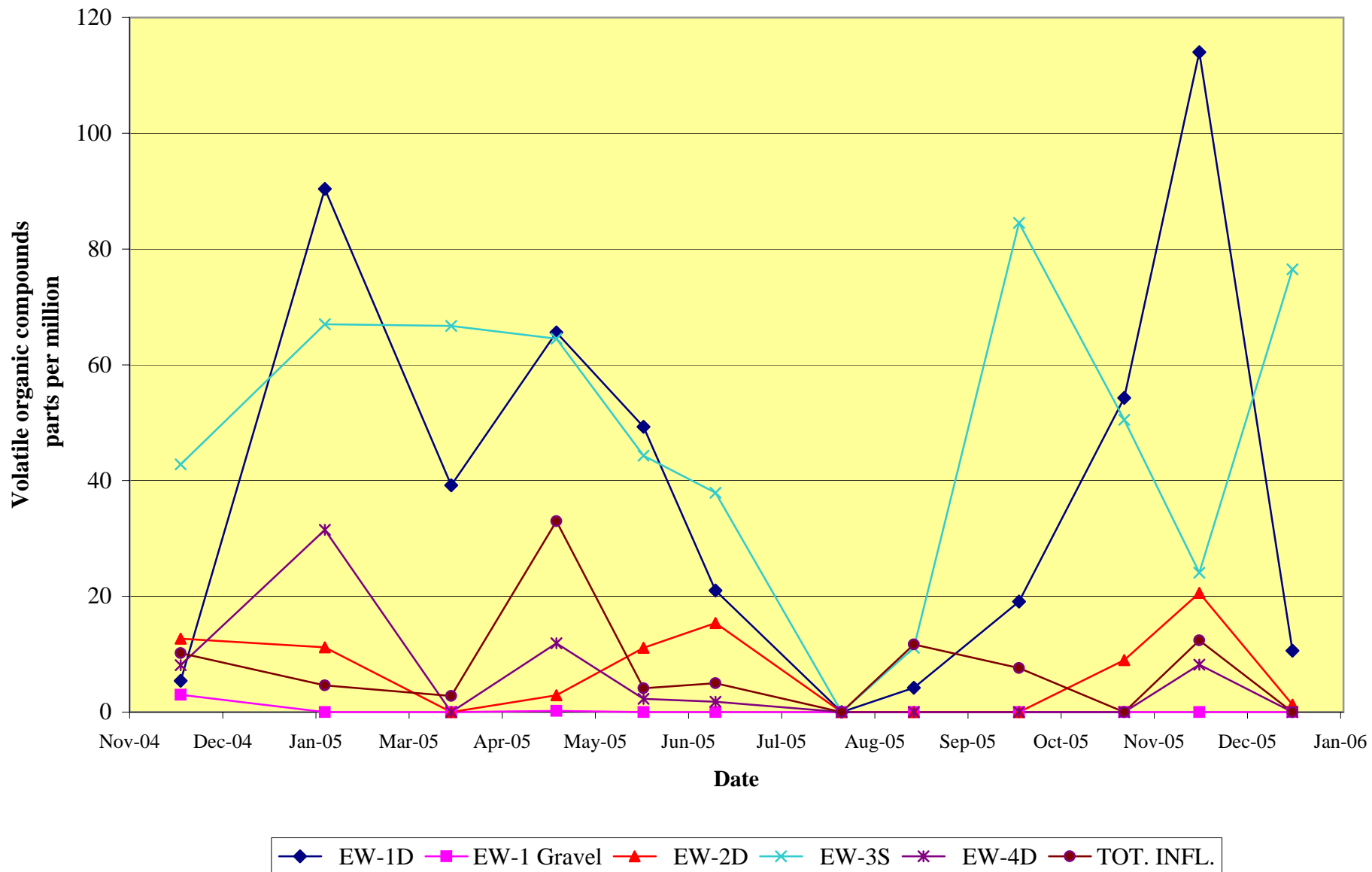

FIGURE 3 Historical 1,1,1-Trichloroethane (TCA) Concentrations

Harley-Davidson Motor Company Operations, Inc.
York Vehicle Operations
1425 Eden Road, York PA 17402

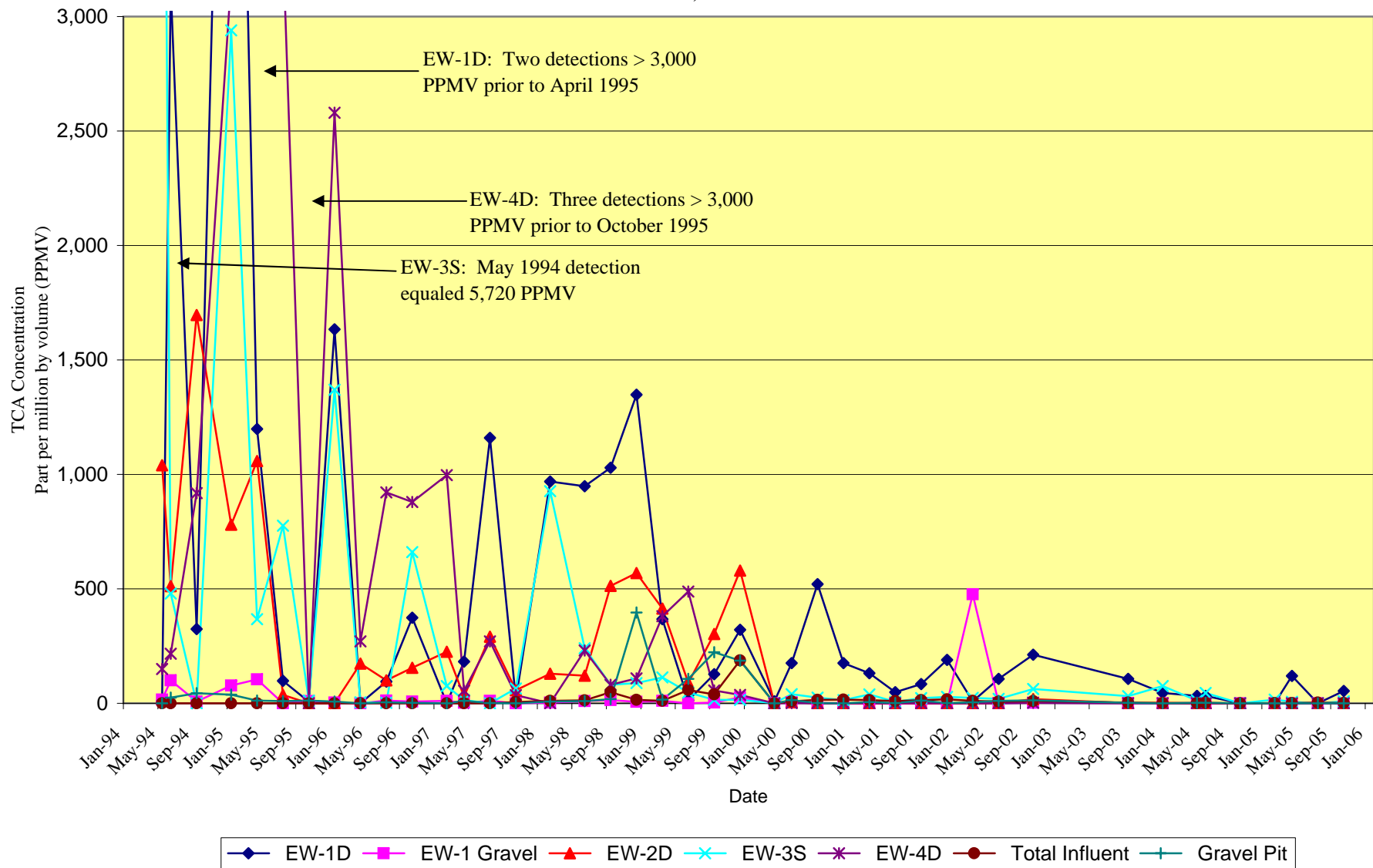

FIGURE 4
Historical Trichloroethylene (TCE) Concentrations
Harley-Davidson Motor Company Operations, Inc.
York Vehicle Operations
1425 Eden Road, York PA 17402

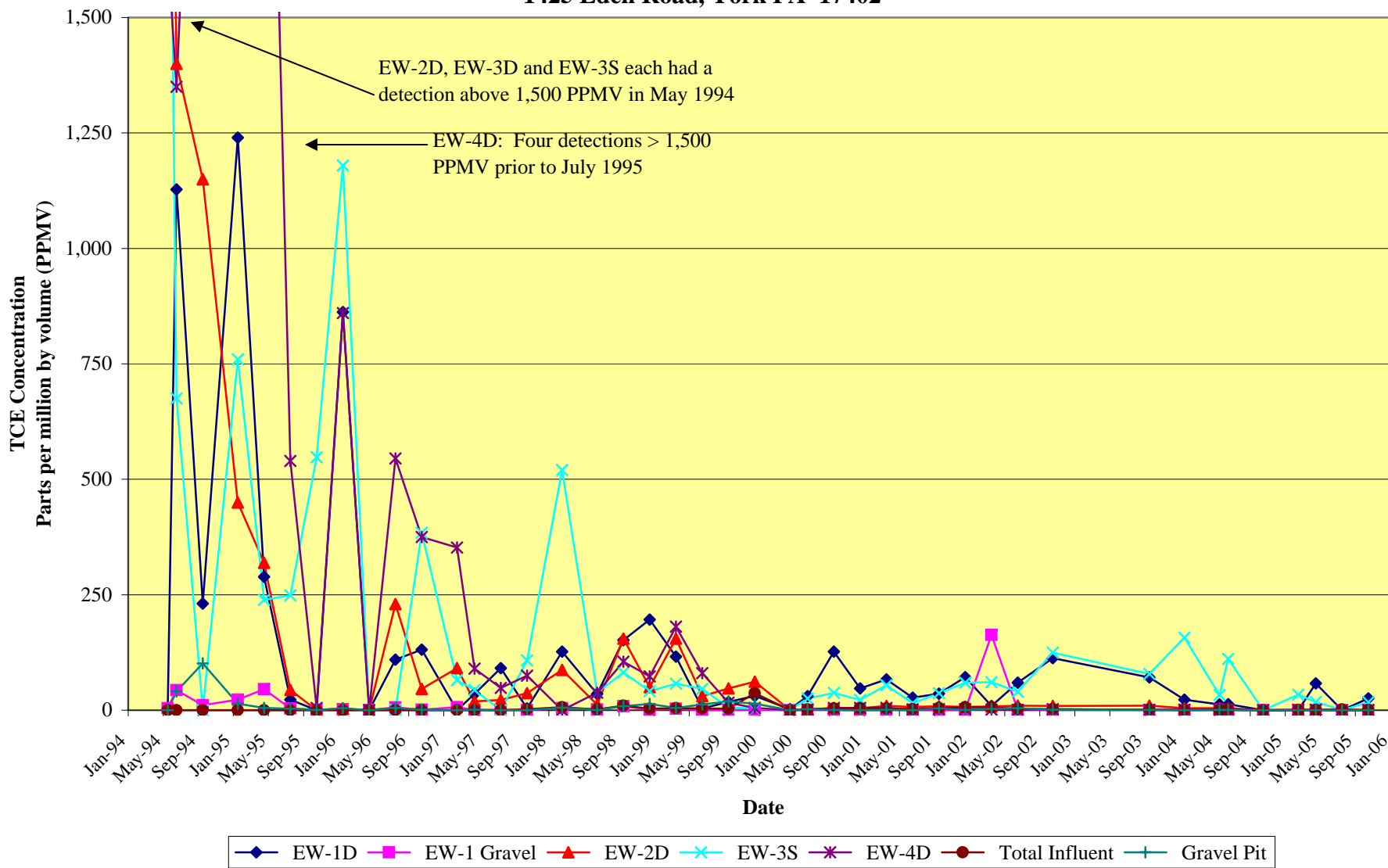

FIGURE 5
Historical Tetrachloroethylene (PCE) Concentrations
 Harley-Davidson Motor Company Operations, Inc.
 York Vehicle Operations
 1425 Eden Road, York PA 17402

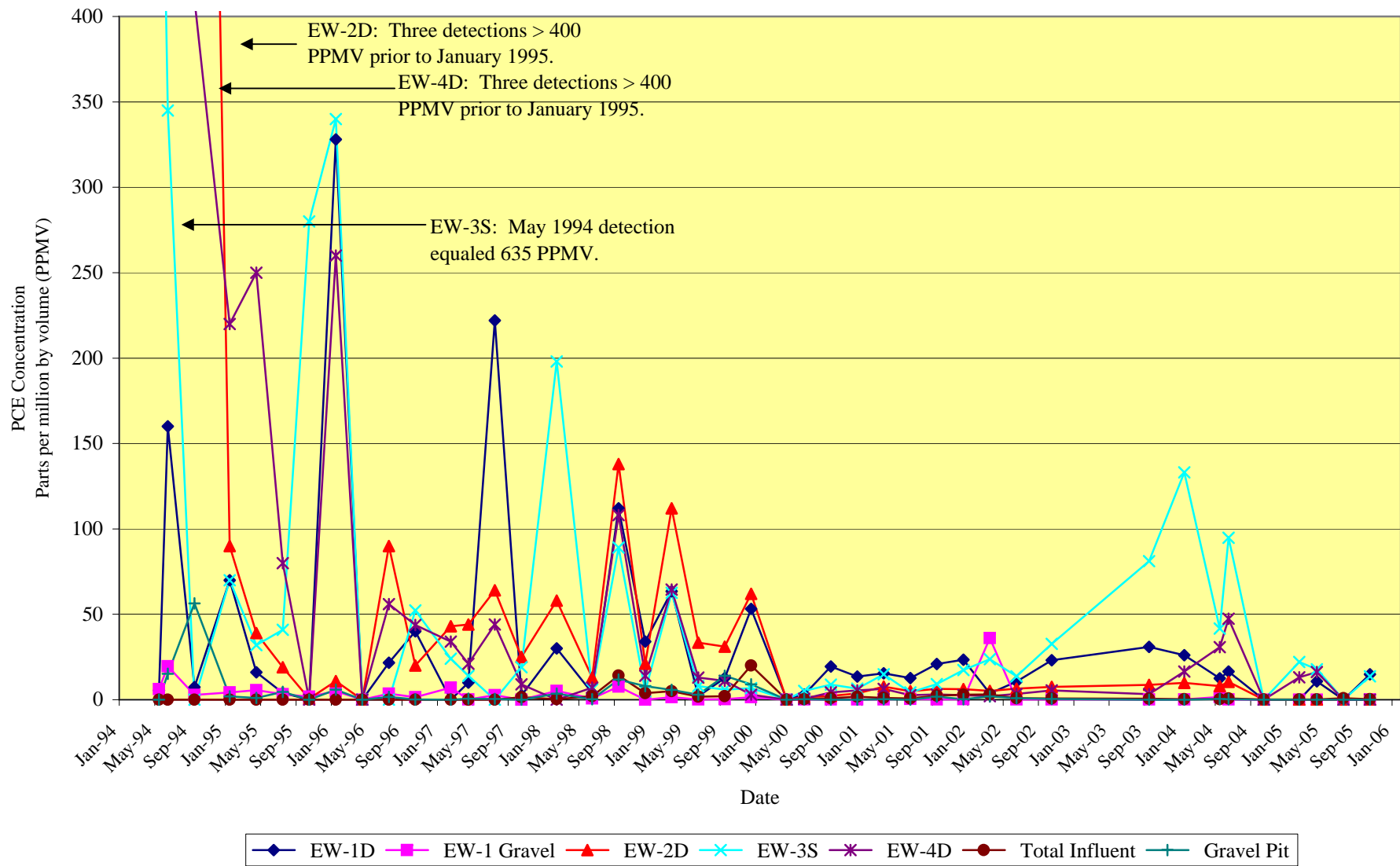

FIGURE 6
Historical cis-1,2-Dichloroethylene (DCE) Concentrations
 Harley-Davidson Motor Company Operations, Inc.
 York Vehicle Operations
 1425 Eden Road, York PA 17402

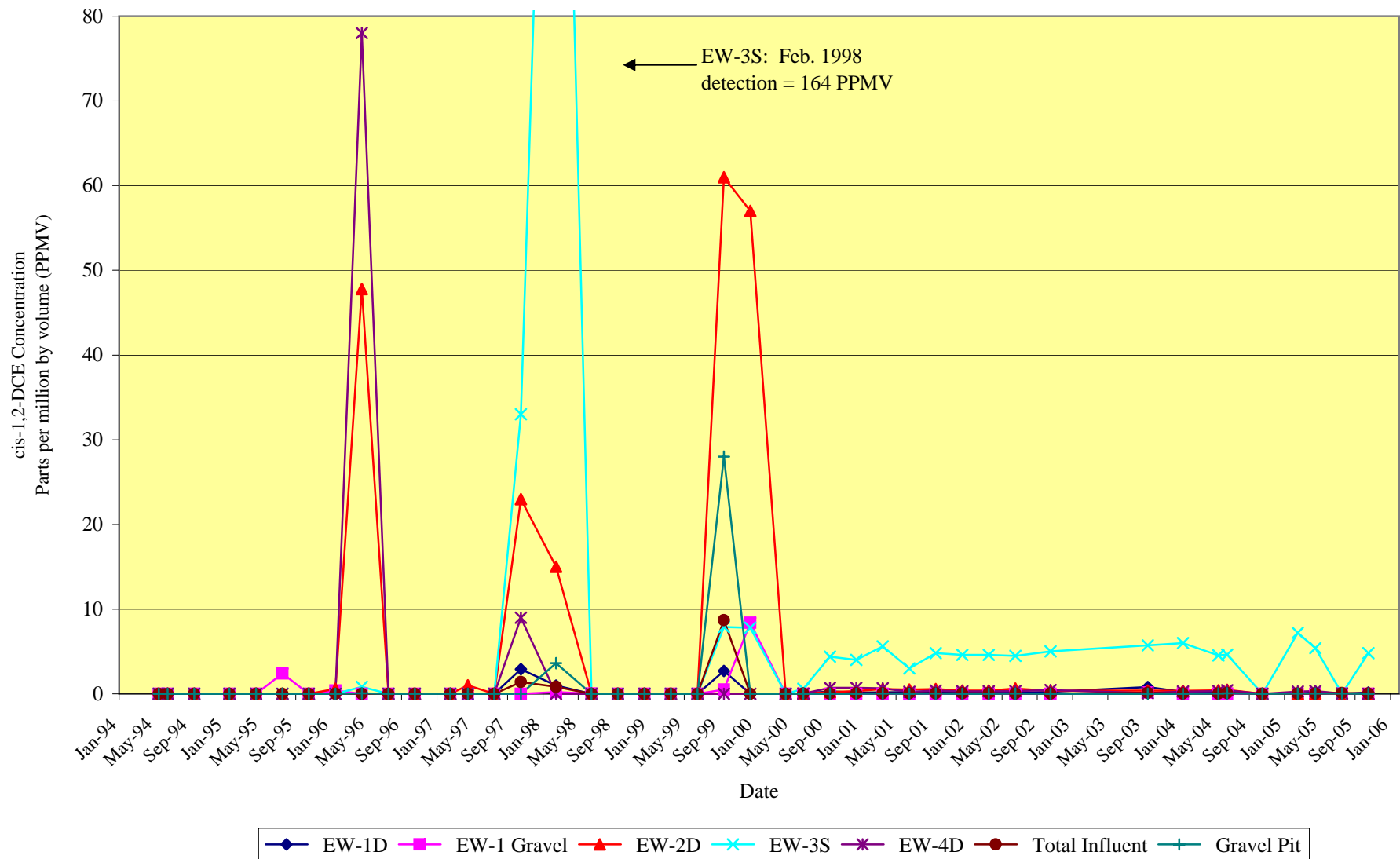
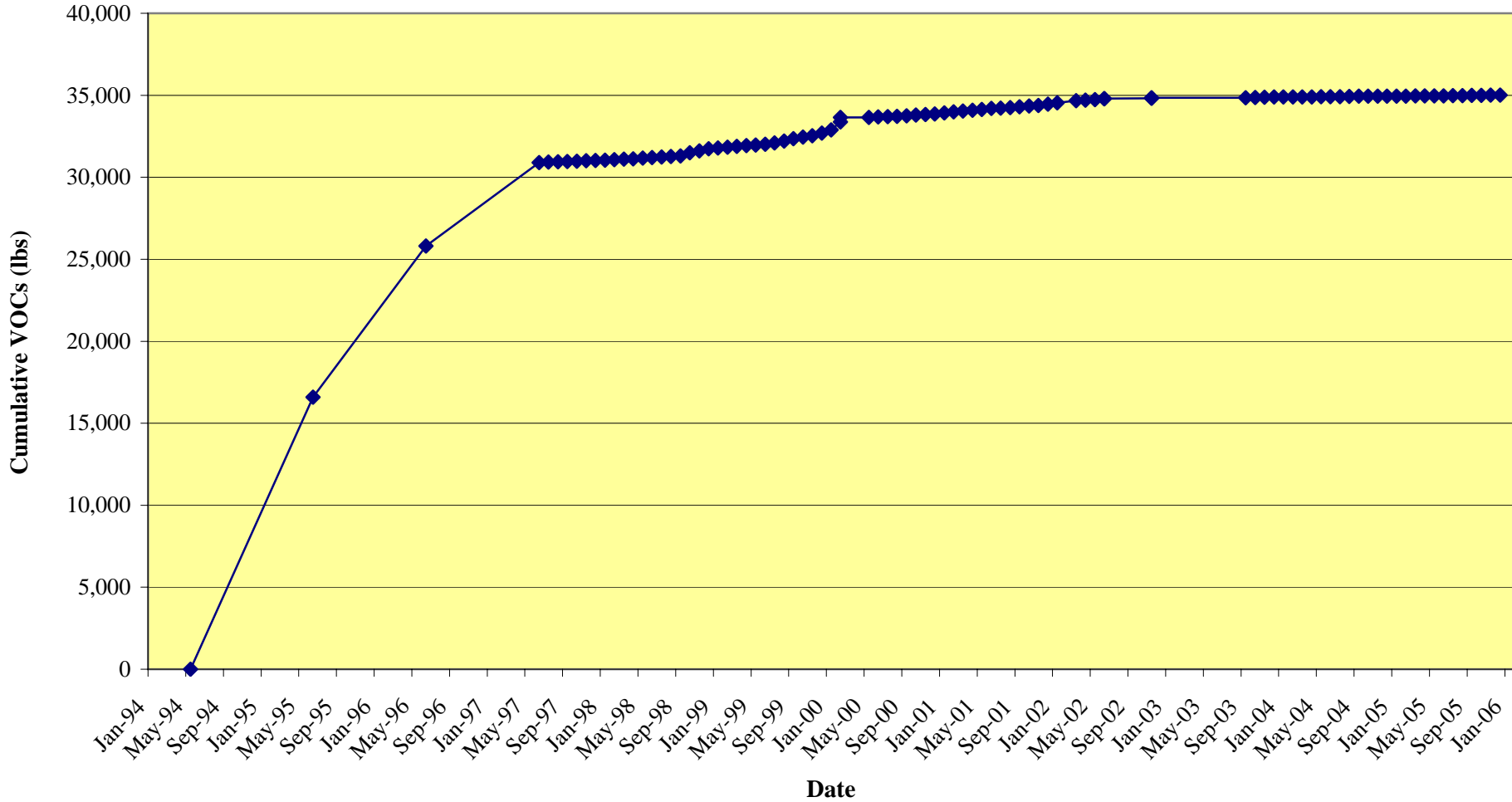

FIGURE 7
North Building 4 SVE Cumulative VOC Recovery
 Harley-Davidson Motor Company Operations, Inc.
 York Vehicle Operations
 1425 Eden Road, York PA 17402



Note: Monthly VOC recovery data was not recorded from start-up through June 1997.

TABLES

TABLE 1
NORTH BUILDING 4 SVE SYSTEM AIRFLOW RATES AND VOC RECOVERY

Harley-Davidson Motor Company Operations, Inc.

York Vehicle Operations

1425 Eden Road, York PA 17402

MEASUREMENT DATE	TOTAL SYSTEM INFLUENT				
	FLOW RATE (SCFM)	BLOWER VAC (IWC)	VOC RECOV (LBS)	CUMUL RECOV (LBS)	RATE (LBS/DAY)
Jun-95	--	--	16,596	16,596	--
Jun-96	--	--	9,205	25,801	--
6/5/1997	126	44	5,099	30,900	--
7/24/1997	129	42	31.5	30,931.5	0.64
8/21/1997	129	42	18.4	30,949.9	0.66
9/4/1997	126	44	9.2	30,959.1	0.66
10/9/1997	133	40	22.5	30,981.5	0.64
11/6/1997	122	46	19.0	31,000.5	0.68
12/4/1997	124	45	17.4	31,017.9	0.62
1/21/1998	133	40	30.3	31,048.2	0.63
2/18/1998	133	40	19.0	31,067.2	0.68
3/17/1998	135	38	31.8	31,099.0	1.18
4/7/1998	158	23	25.1	31,124.0	1.19
5/5/1998	156	24	39.1	31,163.2	1.40
6/2/1998	133	40	38.6	31,201.8	1.38
7/3/1998	133	40	35.0	31,236.8	1.13
8/4/1998	129	42	36.1	31,273.0	1.13
9/1/1998	133	40	30.7	31,303.6	1.10
10/9/1998	120	48	190.1	31,493.7	5.00
11/3/1998	122	46	112.8	31,606.5	4.51
12/1/1998	126	44	128.5	31,735.0	4.59
1/5/1999	133	40	50.9	31,785.9	1.45
2/5/1999	150	30	47.6	31,833.5	1.53
3/2/1999	133	40	43.3	31,876.8	1.73
4/6/1999	127	43	48.3	31,925.1	1.38
5/4/1999	129	42	36.9	31,962.0	1.32
6/8/1999	99	58	46.9	32,008.9	1.34
7/6/1999	133	40	87.7	32,096.5	3.13
8/3/1999	126	44	117.8	32,214.3	4.21
9/7/1999	133	40	139.5	32,353.8	3.99
10/4/1999	122	46	91.2	32,445.0	3.38
11/2/1999	124	45	89.9	32,534.9	3.10
12/22/1999	127	43	157.5	32,692.5	3.15
1/3/2000	124	45	189.5	32,881.9	15.79
2/4/2000	104	56	493.3	33,375.2	15.42
2/25/2000	system shut down		271.5	33,646.8	12.93
4/20/2000	106	79	--	33,646.8	--
5/3/2000	106	79	7.0	33,653.8	0.54
6/15/2000	149	62	23.3	33,677.1	0.54
7/7/2000	167	54	16.8	33,693.9	0.76
8/4/2000	167	54	23.9	33,717.8	0.85
9/8/2000	167	54	29.9	33,747.7	0.85
10/5/2000	120	73	46.2	33,793.9	1.71
11/3/2000	119	74	35.6	33,829.5	1.23
12/1/2000	166	55	34.1	33,863.7	1.22
1/5/2001	166	55	66.3	33,930.0	1.90
2/2/2001	167	54	53.1	33,983.1	1.90
3/2/2001	167	54	53.4	34,036.5	1.91
4/6/2001	167	54	55.8	34,092.3	1.60
5/3/2001	174	52	43.1	34,135.4	1.60
6/8/2001	164	56	59.8	34,195.2	1.66

TABLE 1
NORTH BUILDING 4 SVE SYSTEM AIRFLOW RATES AND VOC RECOVERY

Harley-Davidson Motor Company Operations, Inc.

York Vehicle Operations

1425 Eden Road, York PA 17402

MEASUREMENT DATE	TOTAL SYSTEM INFLUENT				
	FLOW RATE (SCFM)	BLOWER VAC (IWC)	VOC RECOV (LBS)	CUMUL RECOV (LBS)	RATE (LBS/DAY)
7/5/2001	167	54	28.2	34,223.4	1.04
8/3/2001	167	54	30.8	34,254.2	1.06
9/20/2001	166	55	51.0	34,305.2	1.06
10/12/2001	164	56	40.5	34,345.7	1.84
11/2/2001	166	55	38.2	34,383.9	1.82
12/14/2001	167	54	77.4	34,461.3	1.84
1/18/2002	164	56	80.1	34,541.3	2.29
3/20/2002	161	58	132.6	34,673.9	2.25
4/5/2002	167	54	26.5	34,700.4	1.65
5/3/2002	164	56	27.5	34,727.8	1.72
6/7/2002	164	56	59.0	34,786.8	1.68
6/23/2002	system shut down		16.2	34,803.0	1.01
10/25/2002	174	52	-- ¹	34,803.0	--
11/1/2002	167	54	15.9	34,818.8	1.13
11/23/2002	system shut down		22.9	34,841.7	1.09
8/16/2003	171	53	-- ¹	34,841.7	--
9/5/2003	164	56	9.6	34,851.3	0.48
10/3/2003	171	53	11.3	34,862.6	0.46
11/10/2003	178	50	16.1	34,878.8	0.48
12/10/2003	system shut down		13.3	34,892.0	0.50
1/9/2004	171	53	-- ¹	34,892.0	--
2/6/2004	167	54	3.6	34,895.6	0.13
3/6/2004	180	49	3.7	34,899.3	0.13
4/15/2004	174	52	3.7	34,903.0	0.14
5/6/2004	171	53	3.1	34,906.1	0.18
6/3/2004	167	54	4.9	34,911.0	0.38
7/9/2004	176	51	8.9	34,919.9	0.37
8/5/2004	174	52	10.6	34,930.5	0.39
9/10/2004	174	52	12.0	34,942.5	0.39
10/7/2004	171	53	1.3	34,943.8	0.05
11/18/2004	164	56	2.1	34,945.9	0.05
12/17/2004	193	43	0.9	34,946.8	0.05
1/7/2005	176	48	1.2	34,948.0	0.06
2/3/2005	176	48	1.9	34,949.9	0.11
3/17/2005	176	54	4.1	34,954.0	0.11
4/21/2005	176	46	4.1	34,958.1	0.12
5/20/2005	176	48	3.2	34,961.3	0.12
6/13/2005	80	50	2.7	34,964.0	0.12
7/25/2005	80	48	8.4	34,972.5	0.22
8/18/2005	176	53	4.6	34,977.1	0.22
9/22/2005	176	48	16.6	34,993.7	0.47
10/27/2005	176	48	5.2	34,998.8	0.17
11/21/2005	184	48	3.7	35,002.5	0.17
12/22/2005	184	48	5.6	35,008.1	0.18

Notes: --¹ Indicates a startup date, no VOC recovery is calculated until the next monitoring date
Monthly VOC recovery data not recorded from start-up through June 1997.
Beginning in January 2005, flow rate determined from in-line pitot tube (previously from blower curve)

**TABLE 2
BUILDING 4 SOIL VAPOR MONITORING POINT VOC CONCENTRATIONS**

**Harley-Davidson Motor Company Operations, Inc.
York Vehicle Operations
1425 Eden Road, York PA 17402**

SAMPLE LOCATIONS	SAMPLE DATES																				
	5/24/1994	6/22/1994	9/7/1994	1/18/1995	4/26/1995	7/27/1995	10/26/1995	1/4/1996	4/26/1996	7/15/1996	10/10/1996	2/7/1997	4/11/1997	7/24/1997	10/9/1997	2/18/1998	6/2/1998	9/1/1998	12/1/1998	3/2/1999	6/8/1999
I.I.1- TCA																					
EW-1D	11.94	3127.5	324.3	6340	1198	98	6.4	1634	0.09	94.9	374.0	NA	182.0	1160	17	969	948	1029	1348	367	12.6
EW-1S	3.2	180.5	21.1	619	14.3	13.1	11.6	13.9	ND	16.0	16.2	17.2	7.8	45.4	1177	28.8	7.8	85.7	3	13.3	0.9
EW-1 Gravel	16.12	99.9	8.01	77.3	105	ND	9.5	2.7	0.36	12.3	7.7	10.3	2.0	10.7	NA	3.4	10.1	14.4	6	10.5	0.2
EW-2D	1040	512	1696	780	1058	37	0.3	0.3	173	100.0	155.0	225.0	30.0	291	57	129	121	513	569	414	89.3
EW-2S	110	73	54	199	161	ND	13.9	630	ND	ND	0.6	16.5	9.1	1.61	NA	2.6	0.3	11.9	9.5	10.6	0.4
EW-3D	360	ND	204.8	38	248	13	12.5	0.9	0.03	NS	0.5	11.8	0.7	1.39	0.2	ND	4.1	6	2.1	3.4	0.3
EW-3S	5720	480	NS	2940	367	776	11.4	1370	4.3	2.0	661.0	75.0	14.0	NA	65	927	240	81	88.5	113	47
EW-4D	150	217	918	3160	6140	3310	ND	2580	270	921.0	879.0	997.0	55.0	270	36	ND	231	81	109	380	488
EW-4S	40	ND	49.1	84	62.4	ND	9.5	10.8	4.9	14.3	13.5	57.0	5.9	12.8	9.4	1.2	0.7	20.6	3	9	7.4
Gravel Pit	NS	24.3	44.7	37.6	12.1	9.3	11.6	8	ND	4.8	2.4	NA	10.7	1.49	NA	7.09	10.1	18.6	397	15.8	107
Total Influent	NS	NS	NS	NS	NS	NS	NS	NS	NS	NS	NS	NS	NS	NS	5.2	10.3	12.7	48.3	15.4	10.5	57.7
TCE																					
EW-1D	4.05	1127.5	231.1	1240	289	23	ND	862	0.012	109.6	131.0	NA	35.0	91	3.9	127	35	152	196	116	4
EW-1S	15.25	113.2	10.8	137	6.9	4.3	2.5	9	0.44	9.0	4.3	8.1	1.0	1.8	157	13.2	0.7	39.2	3	5.3	0.3
EW-1 Gravel	4.32	43.5	10.8	22.5	45.3	4.0	1.2	2.2	0.8	6.1	1.0	6.3	0.3	0.4	NA	4.6	1.5	8.8	1	3.4	0.1
EW-2D	2860	1400	1150	450	319	44	ND	3.1	ND	230.0	46.2	91.0	19.0	22	37	87	12	155	50	155	30.4
EW-2S	685	380	90.8	92	58	ND	8.4	450	ND	0.01	0.23	36.7	4.7	0.24	NA	8.8	0.2	8.7	3	5.1	0.2
EW-3D	1900	735	154.3	57	239	5.4	8.5	3.5	ND	NS	0.8	7.8	7.6	1.1	0.3	4.9	2	15.6	1.8	4.1	0.4
EW-3S	2485	675	NS	760	239	249	548	1180	ND	1.0	384.0	65.0	44.0	NA	108	520	38	82	41	57.4	46
EW-4D	1645	1350	2635	1680	2825	540	4.8	860	ND	545.0	375.0	352.0	90.0	48	75	0.2	38	105	73	181	80
EW-4S	630	125	130.5	50	20.5	4.1	4	11.8	ND	92.0	4.1	22.0	0.9	0.7	4.2	4	0.1	13.5	1	3.7	0.8
Gravel Pit	NS	40.8	101.3	14.1	5.1	3.2	0.4	4.6	ND	4.8	0.9	NA	1.3	0.16	NA	5.3	0.7	8.7	13.5	4.9	12.4
Total Influent	NS	NS	NS	NS	NS	NS	NS	NS	NS	NS	NS	NS	NS	NS	2.3	6.6	1.8	9.7	3	4.1	3.6
PCE																					
EW-1D	5.52	160	7.3	70	16	4	ND	328	NA	21.7	40.1	NA	10.0	222	2.5	30	4	112	34	63.4	2
EW-1S	2.55	84.1	12.5	15	2.1	5.7	ND	ND	NA	5.7	1.4	7.9	0.2	7.8	56	6.6	0.3	32.8	1	5.9	0.1
EW-1 Gravel	6.11	19.6	2.74	4.2	5.6	3.3	1.8	5	NA	3.5	1.5	7.0	0.1	2.6	NA	5.14	0.7	7.6	ND	1.5	0.1
EW-2D	1480	768	1230	90	39	19	0.6	10.9	NA	90.0	20.0	43.0	44.0	64	25	58	13	138	21	112	33.4
EW-2S	395	796	34.6	56	17.5	8.4	24.6	270	NA	ND	0.1	11.8	8.9	1.7	NA	10.6	0.8	14.7	4.8	7.9	0.3
EW-3D	1040	525	79.4	18	41	7.1	ND	3.3	NA	NS	0.2	8.5	7.8	3.05	0.2	0.94	1.9	18	1.9	4.6	0.2
EW-3S	635	345	NS	70	32	41	280	340	NA	ND	52.2	24.0	14.0	NA	19	198	6	89	5	62.6	8
EW-4D	1290	765	410	220	250	80	ND	260	NA	56.0	43.7	34.0	21.0	44	9	0.02	7	108	14	64.5	13
EW-4S	470	275	127	18	12.2	5.3	ND	23.5	NA	42.0	3.8	9.0	0.2	4.1	3.2	4.2	0.3	23.3	ND	4.3	0.7
Gravel Pit	NS	15.1	56.4	1.9	1.1	4.6	0.05	5.9	NA	1.7	0.2	NA	0.6	0.37	NA	3.5	0.3	11.8	8	5.7	3
Total Influent	NS	NS	NS	NS	NS	NS	NS	NS	NS	NS	NS	NS	NS	NS	1.4	0.28	2	14.1	3.8	5	1.7
c-1,2- DCE																					
EW-1D	ND	ND	ND	ND	ND	ND	0.03	ND	0.03	ND	ND	NA	ND	ND	2.9	0.99	ND	ND	ND	ND	ND
EW-1S	ND	ND	ND	ND	ND	ND	0.01	ND	0.08	ND	ND	ND	ND	ND	173	2.4	0.01	ND	ND	ND	ND
EW-1 Gravel	ND	ND	ND	ND	ND	2.4	ND	0.4	0.008	ND	ND	ND	ND	ND	NA	0.2	0.03	ND	ND	ND	ND
EW-2D	ND	ND	ND	ND	ND	ND	ND	0.6	47.8	ND	ND	ND	1.0	ND	23	15	ND	ND	ND	ND	ND
EW-2S	ND	ND	ND	ND	ND	3.4	ND	ND	0.06	ND	ND	ND	ND	ND	NA	0.2	ND	ND	ND	ND	ND
EW-3D	ND	ND	ND	ND	ND	ND	ND	0.2	0.04	NS	ND	ND	ND	ND	0.04	0.11	0.02	ND	ND	ND	ND
EW-3S	ND	ND	NS	ND	ND	ND	ND	ND	0.82	ND	ND	ND	ND	NA	33	164	ND	ND	ND	ND	ND
EW-4D	ND	ND	ND	ND	ND	ND	ND	ND	78	ND	ND	ND	ND	ND	9	ND	ND	ND	ND	ND	ND
EW-4S	ND	ND	ND	ND	ND	3.0	ND	ND	0.09	ND	ND	ND	ND	ND	2.1	ND	ND	ND	ND	0.13	ND
Gravel Pit	NS	ND	ND	ND	ND	ND	ND	ND	0.05	ND	ND	NA	ND	ND	NA	3.61	ND	ND	ND	ND	ND
Total Influent	NS	NS	NS	NS	NS	NS	NS	NS	NS	NS	NS	NS	NS	NS	1.4	0.82	ND	ND	ND	ND	ND
Vinyl-chloride																					
EW-1D	NS	NS	NS	NS	NS	NS	NS	NS	NS	NS	NS	NS	NS	NS	NS	NS	NS	NS	NS	NS	NS
EW-1S	NS	NS	NS	NS	NS	NS	NS	NS	NS	NS	NS	NS	NS	NS	NS	NS	NS	NS	NS	NS	NS
EW-1 Gravel	NS	NS	NS	NS	NS	NS	NS	NS	NS	NS	NS	NS	NS	NS	NS	NS	NS	NS	NS	NS	NS
EW-2D	NS	NS	NS	NS	NS	NS	NS	NS	NS	NS	NS	NS	NS	NS	NS	NS	NS	NS	NS	NS	NS
EW-2S	NS	NS	NS	NS	NS	NS	NS	NS	NS	NS	NS	NS	NS	NS	NS	NS	NS	NS	NS	NS	NS
EW-3D	NS	NS	NS	NS	NS	NS	NS	NS	NS	NS	NS	NS	NS	NS	NS	NS	NS	NS	NS	NS	NS
EW-3S	NS	NS	NS	NS	NS	NS	NS	NS	NS	NS	NS	NS	NS	NS	NS	NS	NS	NS	NS	NS	NS
EW-4D	NS	NS	NS	NS	NS	NS	NS	NS	NS	NS	NS	NS	NS	NS	NS	NS	NS	NS	NS	NS	NS
EW-4S	NS	NS	NS	NS	NS	NS	NS	NS	NS	NS	NS	NS	NS	NS	NS	NS	NS	NS	NS	NS	NS
Gravel Pit	NS	NS	NS	NS	NS	NS	NS	NS	NS	NS	NS	NS	NS	NS	NS	NS	NS	NS	NS	NS	NS
Total Influent	NS	NS	NS	NS	NS	NS	NS	NS	NS	NS	NS	NS	NS	NS	NS	NS	NS	NS	NS	NS	NS

ND - Not Detected
 NS - Not Sampled
 NA - Not Analyzed
 All concentrations are in Part per million by volume (PPMV)

TABLE 2
BUILDING 4 SOIL VAPOR MONITORING POINT VOC CONCENTRATIONS
Harley-Davidson Motor Company Operations, Inc.
York Vehicle Operations
1425 Eden Road, York PA 17402

SAMPLE LOCATIONS	SAMPLE DATES																					
	9/7/1999	12/22/1999	4/20/2000	6/16/2000	9/8/2000	12/1/2000	3/2/2001	6/8/2001	9/20/2001	12/14/2001	3/20/2002	6/7/2002	10/25/2002	9/5/2003	1/9/2004	5/6/2004	6/3/2004	10/7/2004	2/3/2005	4/21/2005	7/25/2005	10/27/2005
1,1,1- TCA																						
EW-1D	127	321	8.5	176	521	176	132	48	83.7	190	8.7	106	212	106.553	45.129	32.102	31.968	ND	ND	119.483	0.006	53.573
EW-1S	6.6	13	NS	NS	NS	NS	NS	NS	NS	NS	NS	NS	NS	NS	NS	NS	NS	NS	NS	NS	NS	NS
EW-1 Gravel	3.2	25.4	0.01	4.8	1.8	0.78	0.43	0.21	0.52	0.68	477	0.7	2	0.722	0.142	1.237	0.303	ND	ND	0.02	0.007	0.312
EW-2D	303	580	ND	4.8	0.03	0.03	0.06	0.03	0.07	0.05	0.19	0.04	18.6	1.313	2.052	0.342	0.243	ND	ND	0.00	0.005	ND
EW-2S	3.2	4.4	NS	NS	NS	NS	NS	NS	NS	NS	NS	NS	NS	NS	NS	NS	NS	NS	NS	NS	NS	NS
EW-3D	2.4	136	NS	NS	NS	NS	NS	NS	NS	NS	NS	NS	NS	NS	NS	NS	NS	NS	NS	NS	NS	NS
EW-3S	15.6	15.3	0.96	39.8	25.3	14	38.5	6.3	23	27.5	23.4	19.6	62.4	31.186	75.259	11.415	44.99	ND	15.887	6.73	0.005	8.259
EW-4D	56	36.6	0.03	0.8	0.12	0.16	0.11	0.05	0.04	0.07	0.02	0.06	2.4	0.321	0.344	0.368	0.426	ND	0.279	0.258	0.007	ND
EW-4S	22.5	126	NS	NS	NS	NS	NS	NS	NS	NS	NS	NS	NS	NS	NS	NS	NS	NS	NS	NS	NS	NS
Gravel Pit	223	186	0.01	14.2	1.4	NS	5.2	0.85	11.4	1.5	4	10.3	13.2	2.204	0.027	2.093	2.233	ND	ND	ND	0.005	ND
Total Influent	39.2	188	0.01	8.1	15.5	16.1	13.9	9.7	14.3	17.4	10.8	7.9	9.8	3.628	0.701	1.125	2.57	0.238	0.582	0.806	2.699	0.976
TCE																						
EW-1D	17.7	31.1	2.4	30.1	127	47.4	66.6	27.1	35.7	71.3	9.1	59.9	113	70.993	22.916	12.58	12.804	ND	0.035	58.181	0.059	25.508
EW-1S	0.8	1.5	NS	NS	NS	NS	NS	NS	NS	NS	NS	NS	NS	NS	NS	NS	NS	NS	NS	NS	NS	NS
EW-1 Gravel	0.7	1.5	ND	0.6	0.42	0.23	0.21	0.3	0.24	0.34	163	0.39	0.57	0.387	0.123	0.856	0.17	ND	0.035	0.051	0.06	0.152
EW-2D	47	62	ND	2	4.5	4.5	9.2	6.8	8.5	7.2	8.4	9.6	9.4	9.551	4.103	4.305	4.163	ND	0.026	0.052	0.07	ND
EW-2S	1.1	0.5	NS	NS	NS	NS	NS	NS	NS	NS	NS	NS	NS	NS	NS	NS	NS	NS	NS	NS	NS	NS
EW-3D	0.4	15.4	NS	NS	NS	NS	NS	NS	NS	NS	NS	NS	NS	NS	NS	NS	NS	NS	NS	NS	NS	NS
EW-3S	6.2	3.1	0.85	25.3	37.6	22.1	54.3	15.2	36.9	59.5	60.5	40.2	124	78.385	157.038	33.271	110.99	0.009	33.61	17.763	0.062	17.543
EW-4D	16	5	0.04	1.2	4.9	4.7	5.1	1.7	2.1	2.2	1.2	0.8	2.9	0.404	0.962	1.329	1.865	ND	1.324	1.121	0.082	0.006
EW-4S	4.2	17.3	NS	NS	NS	NS	NS	NS	NS	NS	NS	NS	NS	NS	NS	NS	NS	NS	NS	NS	NS	NS
Gravel Pit	19	14	ND	2.3	0.28	NS	1.3	0.2	3.7	0.47	2.8	4.1	1.2	0.478	0.036	0.652	0.46	ND	0.042	0.044	0.057	ND
Total Influent	3	37	ND	1.8	3.9	4.6	3.9	2.2	5	6.4	6	3.5	2.3	1.195	0.385	0.459	0.868	0.177	0.382	0.313	1.482	0.551
PCE																						
EW-1D	12.7	53.2	0.33	2.9	19.4	13.6	15.5	12.7	20.9	23.4	3.6	10.6	23.1	30.887	26.058	12.489	16.478	ND	0.014	10.749	0.036	14.906
EW-1S	0.4	1.4	NS	NS	NS	NS	NS	NS	NS	NS	NS	NS	NS	NS	NS	NS	NS	NS	NS	NS	NS	NS
EW-1 Gravel	0.3	1.4	ND	0.1	0.1	0.11	0.1	0.41	0.2	0.28	36.1	0.1	0.17	0.193	0.146	1.578	0.194	ND	0.032	0.038	0.037	0.152
EW-2D	31	62	ND	1.5	2.2	3.7	7.6	5	6.3	6.2	5.2	6.5	7.6	8.651	9.868	7.998	10.44	ND	0.012	0.034	0.055	ND
EW-2S	1.6	1.2	NS	NS	NS	NS	NS	NS	NS	NS	NS	NS	NS	NS	NS	NS	NS	NS	NS	NS	NS	NS
EW-3D	0.3	8.1	NS	NS	NS	NS	NS	NS	NS	NS	NS	NS	NS	NS	NS	NS	NS	NS	NS	NS	NS	NS
EW-3S	5.9	6.7	0.19	5.2	8.8	6.5	14.9	4.3	9.2	17.4	23.7	13.7	32.7	81.128	133.142	41.652	94.75	0.022	22.058	17.886	0.042	13.664
EW-4D	11	3	0.01	0.6	4.3	5.5	6.3	2.7	3.1	2.6	2	3.5	5.4	3.302	16.552	30.782	47.359	0.032	13.042	16.19	0.061	ND
EW-4S	1.8	24.4	NS	NS	NS	NS	NS	NS	NS	NS	NS	NS	NS	NS	NS	NS	NS	NS	NS	NS	NS	NS
Gravel Pit	14	9	ND	0.3	0.04	NS	0.33	0.07	1.7	0.23	1.9	0.92	0.51	0.131	0.068	0.399	0.251	ND	0.022	0.024	0.037	ND
Total Influent	2	20	ND	0.3	0.95	1.8	1.1	0.07	2.4	3	3.1	0.83	0.78	0.605	0.331	0.356	0.786	0.14	0.17	0.162	0.941	0.344
c-1,2- DCE																						
EW-1D	2.7	ND	ND	0.03	0.3	0.15	0.18	0.22	0.25	0.26	0.02	0.13	0.23	0.8	0.23	0.15	0.16	ND	ND	0.23	0.02	0.14
EW-1S	0.4	3.2	NS	NS	NS	NS	NS	NS	NS	NS	NS	NS	NS	NS	NS	NS	NS	NS	NS	NS	NS	NS
EW-1 Gravel	0.5	8.4	ND	0.01	ND	ND	ND	0.01	0.02	0.02	0.21	ND	ND	0.14	0.03	0.02	0.02	ND	ND	ND	0.02	0.01
EW-2D	61	57	ND	0.03	0.22	0.33	0.57	0.51	0.57	0.39	0.35	0.62	0.37	0.39	0.36	0.42	0.47	ND	ND	0.02	0.03	ND
EW-2S	0.6	1.8	NS	NS	NS	NS	NS	NS	NS	NS	NS	NS	NS	NS	NS	NS	NS	NS	NS	NS	NS	NS
EW-3D	ND	38.3	NS	NS	NS	NS	NS	NS	NS	NS	NS	NS	NS	NS	NS	NS	NS	NS	NS	NS	NS	NS
EW-3S	7.9	7.8	0.01	0.6	4.4	4	5.6	3	4.8	4.6	4.2	4.5	5	5.72	5.99	4.55	4.62	ND	7.22	5.4	0.02	4.8
EW-4D	ND	ND	ND	0.04	0.72	0.7	0.64	0.25	0.38	0.29	0.11	0.34	0.44	0.09	0.27	0.33	0.41	ND	0.27	0.33	0.02	0.01
EW-4S	1.3	ND	NS	NS	NS	NS	NS	NS	NS	NS	NS	NS	NS	NS	NS	NS	NS	NS	NS	NS	NS	NS
Gravel Pit	28	ND	ND	0.01	ND	NS	0.02	ND	0.04	ND	0.04	0.02	ND	ND	ND	0.02	0.05	ND	0.02	0.02	0.02	ND
Total Influent	8.7	ND	ND	0.02	0.03	0.05	0.07	0.05	0.07	0.07	0.04	0.04	0.03	0.12	0.03	0.03	0.08	ND	0.04	0.03	0.1	0.02
Vinyl-chloride																						
EW-1D	NS	NS	NS	NS	NS	NS	NS	NS	NS	NS	NS	NS	NS	NS	NS	NS	NS	NS	NS	NS	NS	NS
EW-1S	NS	NS	NS	NS	NS	NS	NS	NS	NS	NS	NS	NS	NS	NS	NS	NS	NS	NS	NS	NS	NS	NS
EW-1 Gravel	NS	NS	NS	NS	NS	NS	NS	NS	NS	NS	NS	NS	NS	NS	NS	NS	NS	NS	NS	NS	NS	NS
EW-2D	NS	NS	NS	NS	NS	NS	NS	NS	NS	NS	NS	NS	NS	NS	NS	NS	NS	NS	NS	NS	NS	NS
EW-2S	NS	NS	NS	NS	NS	NS	NS	NS	NS	NS	NS	NS	NS	NS	NS	NS	NS	NS	NS	NS	NS	NS
EW-3D	NS	NS	NS	NS	NS	NS	NS	NS	NS	NS	NS	NS	NS	NS	NS	NS	NS	NS	NS	NS	NS	NS
EW-3S	NS	NS	NS	NS	NS	NS	NS	NS	NS	NS	NS	NS	NS	NS	NS	NS	NS	NS	NS	NS	NS	NS
EW-4D	NS	NS	NS	NS	NS	NS	NS	NS	NS	NS	NS	NS	NS	NS	NS	NS	NS	NS	NS	NS	NS	NS
EW-4S	NS	NS	NS	NS	NS	NS	NS	NS	NS	NS	NS	NS	NS	NS	NS	NS	NS	NS	NS	NS	NS	NS
Gravel Pit	NS	NS	NS	NS	NS	NS	NS	NS	NS	NS	NS	NS	NS	NS	NS	NS	NS	NS	NS	NS	NS	NS
Total Influent	NS	NS	NS	NS	NS	NS	NS	NS	NS	NS	NS	NS	NS	NS	NS	NS	NS	NS	NS	NS	NS	NS

ND - Not Detected
NS - Not Sampled
NA - Not Analyzed
All concentrations are in Part per million by volume (PPMV)